

対象年齢
15才以上

TRANSFORMERS REACTIVATE

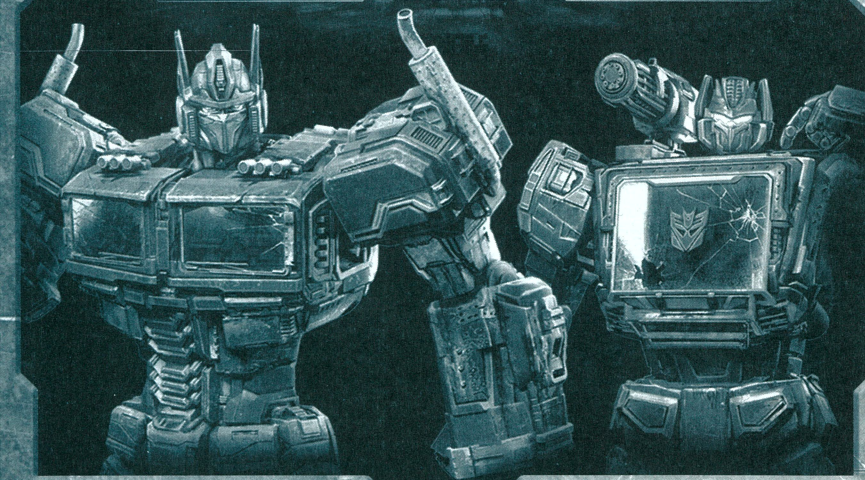

OPTIMUS PRIME

SOUNDWAVE

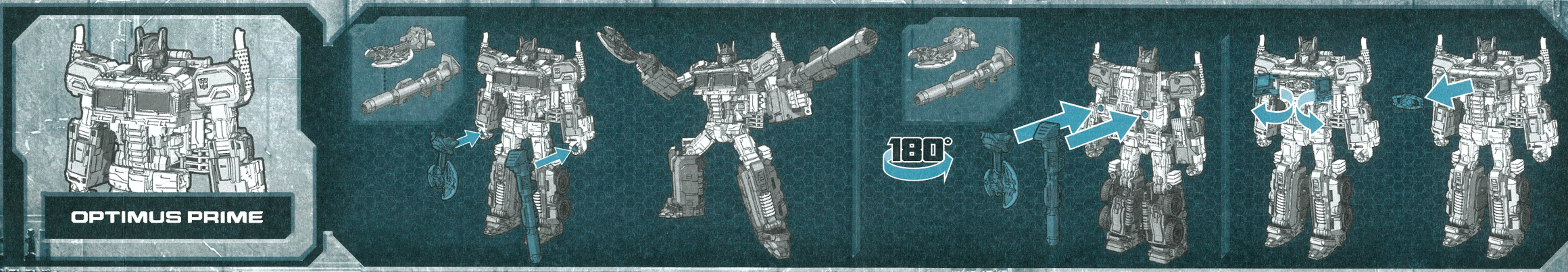

OPTIMUS PRIME

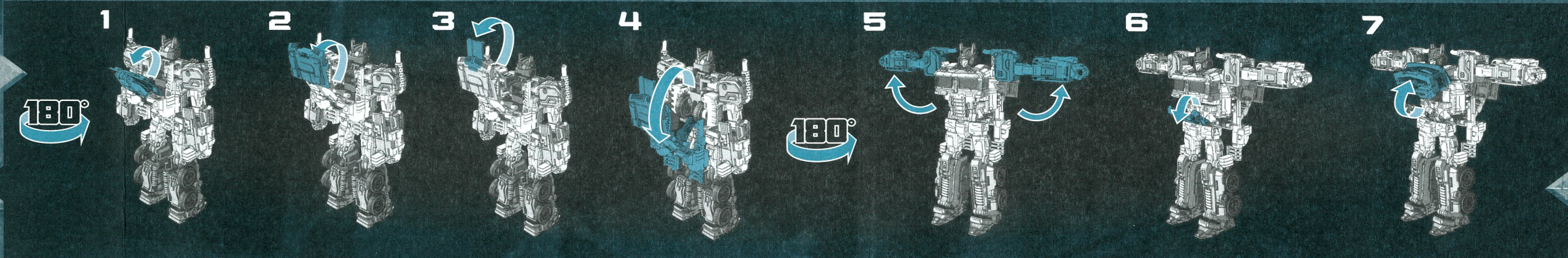

180°

180°

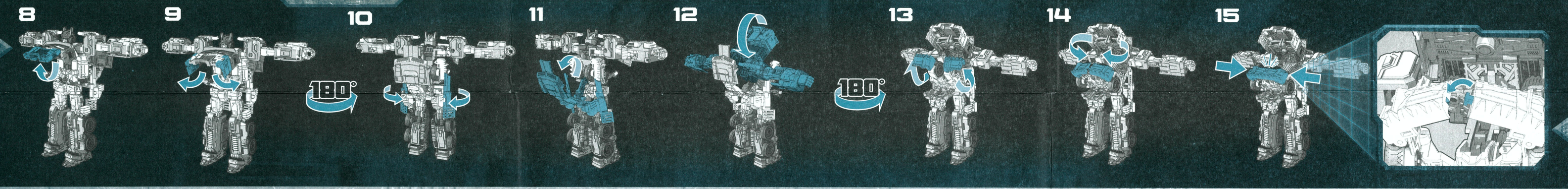

180°

180°

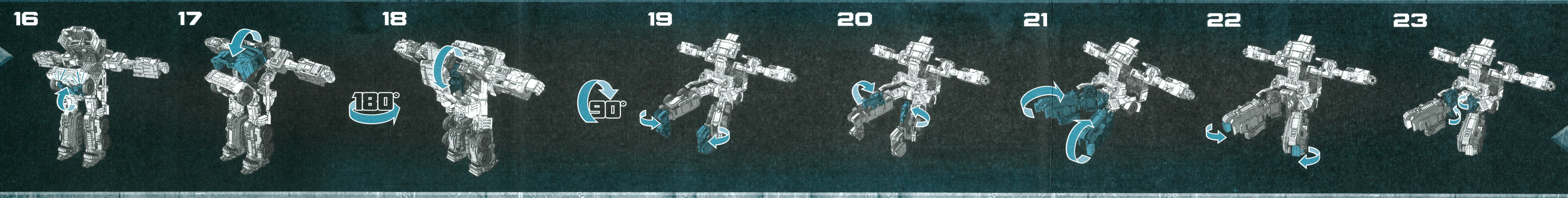

180°

90°

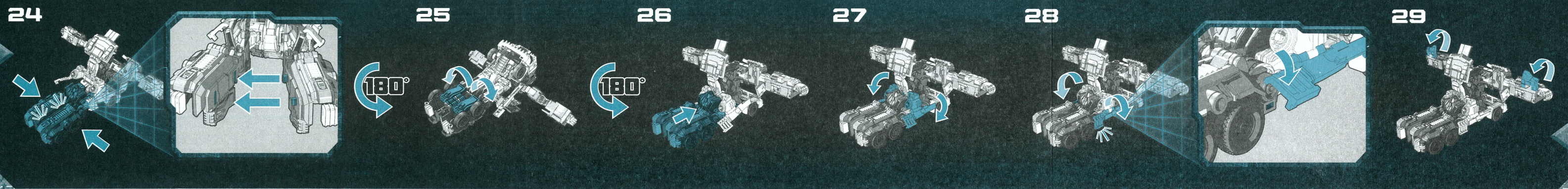

180°

180°

30

31

32

33

34

35

36

37

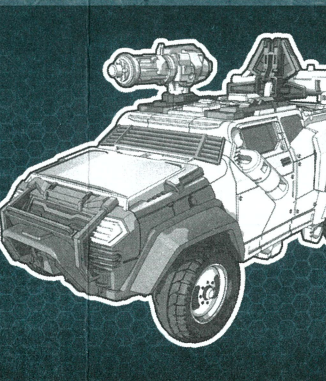
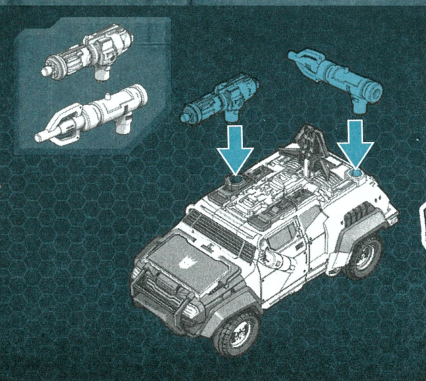
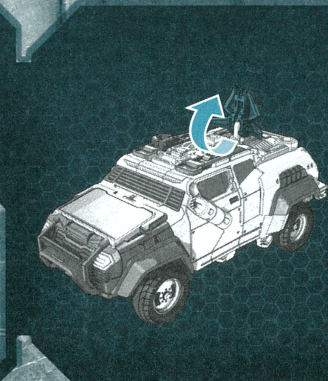
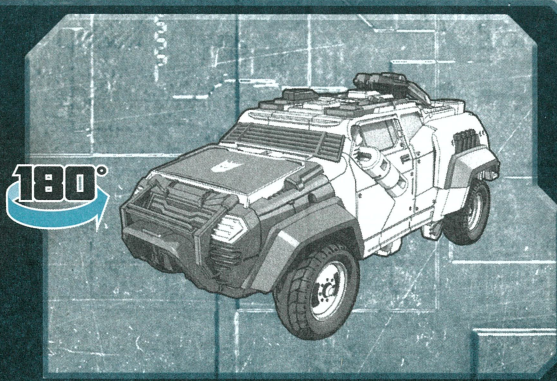
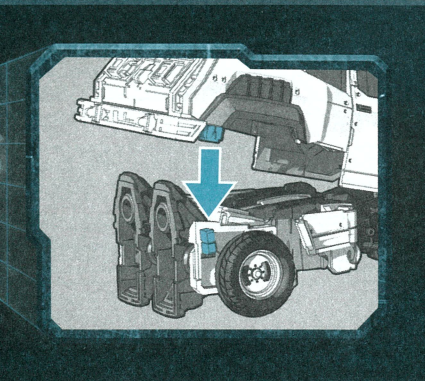
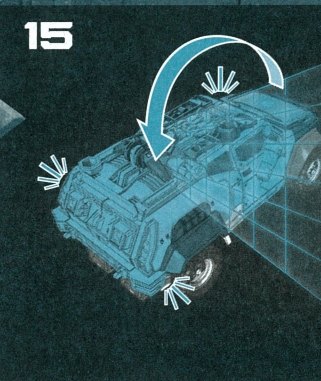
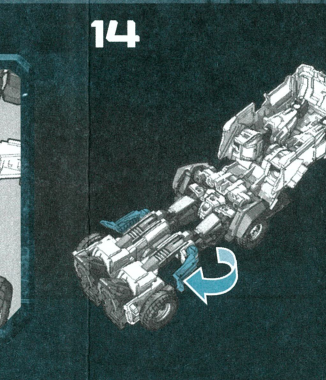
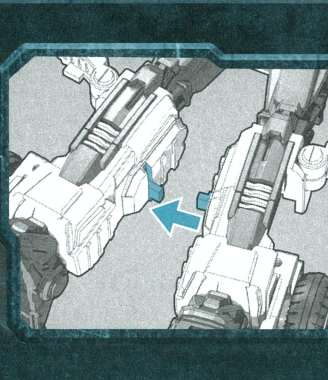
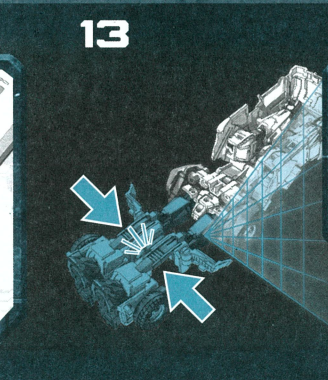
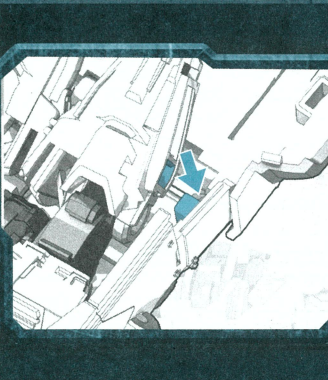
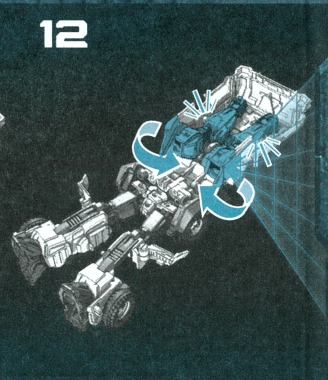
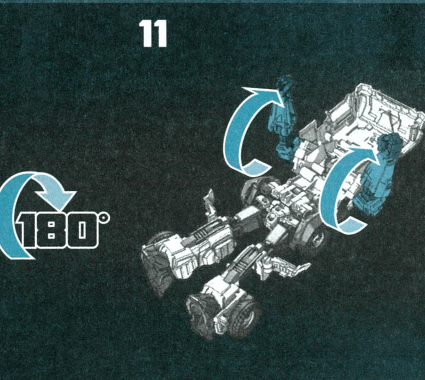
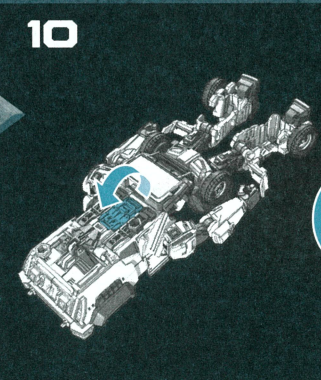
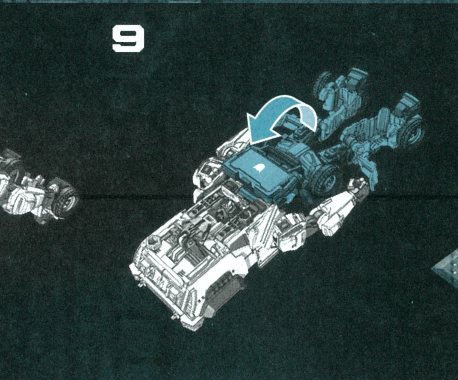
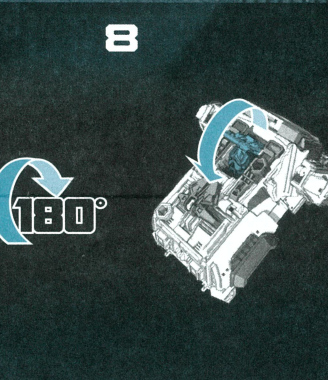
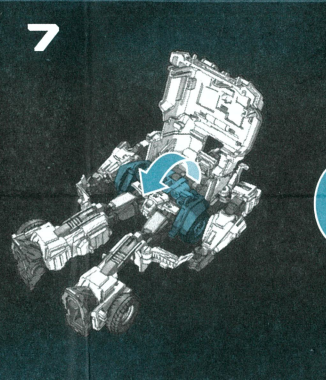
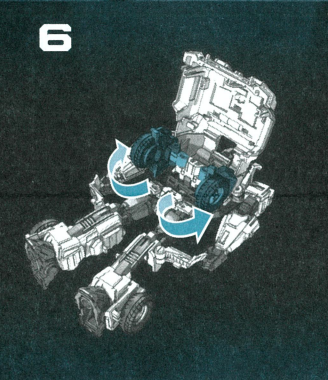
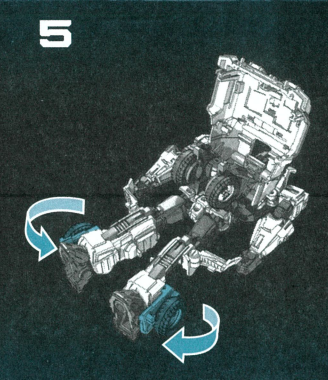
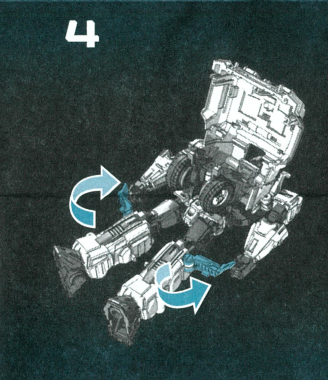
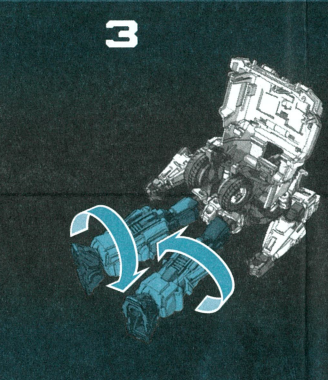
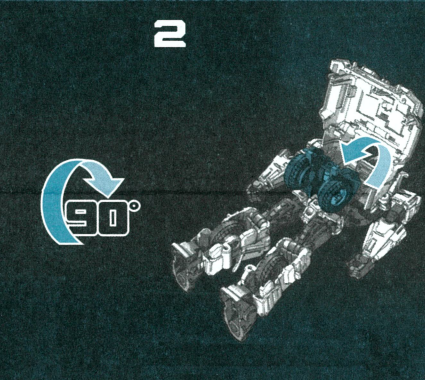
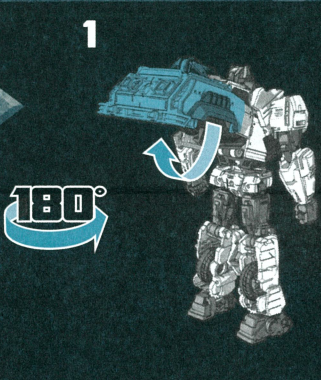
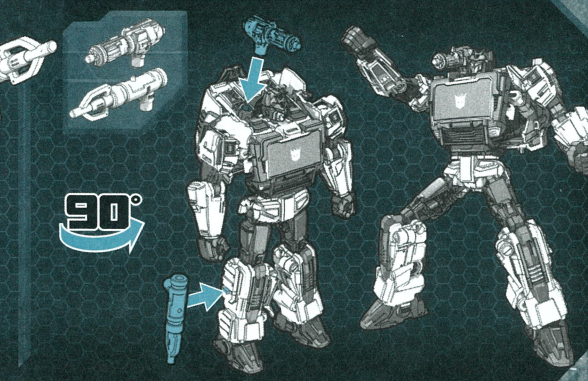
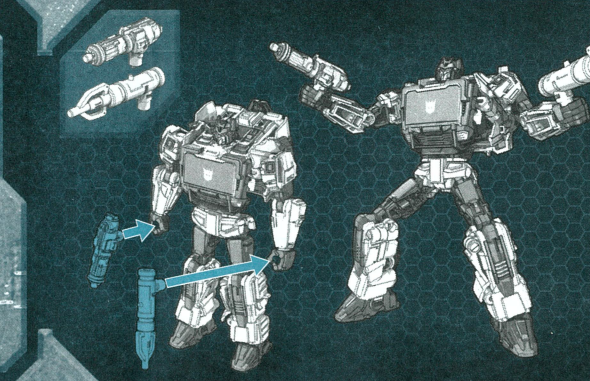
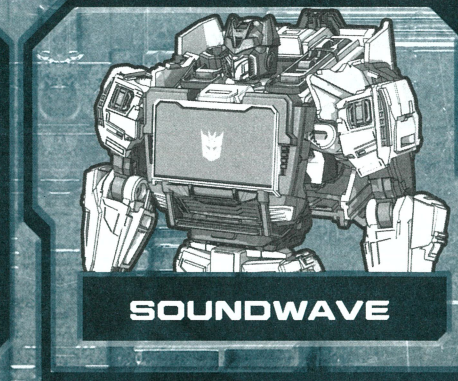
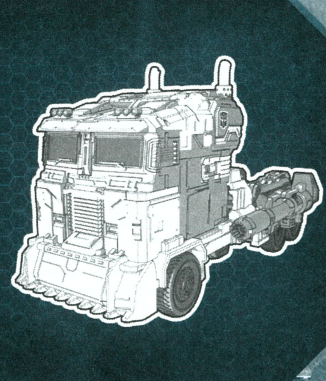
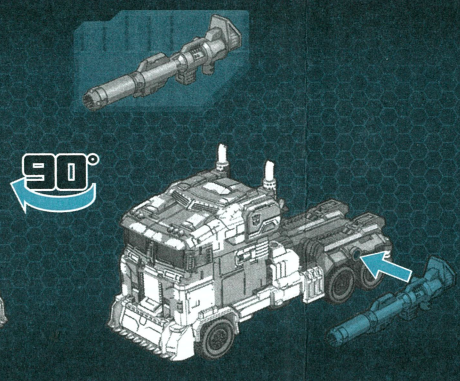
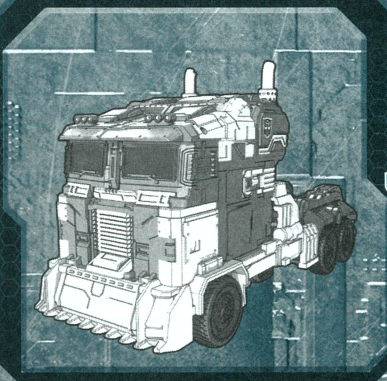
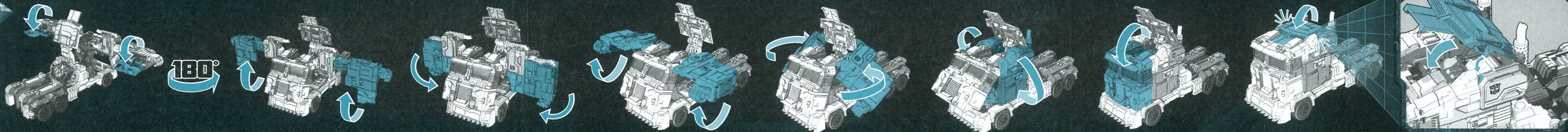

- (en) Retain instructions for future reference.
- (fr) Conservez ces instructions pour référence ultérieure.
- (de) Bitte die Anleitung für spätere Rückfragen aufbewahren.
- (es) Conserve estas instrucciones para futuras referencias.
- (pt) Guardar instruções para eventuais consultas.
- (it) Conserva le istruzioni come futuro riferimento.
- (nl) Bewaar de gebruiksaanwijzing om later nog eens te lezen.
- (sv) Spara instruktionerna för att kunna hänvisa till dem i framtiden.
- (da) Gem vejledninger til fremtidig referencebrug.
- (no) Ta vare på disse instruksjonene for fremtidig referanse.
- (fi) Säilytä nämä tiedot tulevaa tarvetta varten.
- (el) Φυλάξτε τις οδηγίες για μελλοντική αναφορά.
- (pl) Zachowaj instrukcje na przyszłość.
- (hu) Őrizd meg a használati útmutatót.
- (tr) lilerde basyurmak üzere talimatları saklayın.
- (cs) tyto informace uschovejte pro budoucí použití.
- (sk) Návod si odložte na použitie v budúcnosti.
- (ro) Păstrează instrucțiunile pentru a le consulta în viitor.
- (bg) Запазете инструкциите за бъдещи справки.
- (hr) Sačuvajte upute za buduću upotrebu.
- (sl) Instrukcija pasiljite ateičaji.
- (et) Havadlla shrani, mogoče jih boš še potreboval.
- (uk) Збережіть інструкції для подальшого використання.
- (lt) Išsaugokite šias instrukcijas, jei jos dar reikės.
- (lv) Ieta juhised edasiseks kasutamiseks alles.
- (lv) Saglabājiet instrukciju atsaucēi.
- (ar) احتفظ بالتعليمات للرجوع إليها في المستقبل.

SPLASH DAMAGE and its logo are registered trademarks of Splash Damage Ltd. All rights reserved.
 Manufactured under license from TOMY Company, Ltd. TAKARATOMY logo is property of Tomy Company, Ltd.
 TRANSFORMERS and HASBRO and all related trademarks and logos are trademarks of Hasbro, Inc. © 2023 Hasbro.
 Hasbro, Pawtucket, RI 02861-1059 USA. HASBRO CANADA, LONGUEUIL, QC, CANADA J4G 1G2. US/CANADA TEL: 1-800-255-5516. Importado por: HASBRO DE MEXICO, S. DE R.L. DE C.V. Boulevard Manuel Avila Camacho #32, piso 3, Colonia Lomas de Chapultepec I Sección, Alcaldía Miguel Hidalgo, C.P. 11000, Ciudad de México, México. Centro de Servicio para México: TEL: 5876-2998 y para el interior de la República TEL: 01-800-7-12-62-25. Manufactured by/Produced by: Hasbro SA, Rue Emile-Boéchat 31, 2800 Delémont, CH. Represented by/Reprezentat de: Hasbro, De Entree 240, 1101 EE Amsterdam, NL. © Hasbro UK Ltd., P.O. Box 43, Newport, NP19 4YH, UK. © Uretici Firma Bilgileri: Hasbro SA, Rue Emile-Boéchat 31, 2800 Delémont Isvire TEL +41 324210800. Hasbro Oyuncak San. ve Tic. A.Ş. tarafından ithal edilmiştir. Tüketicilerimiz için: Burhaniye Mah. Abdullahaga Cad. No: 51/2 34676 Beylerbeyi İstanbul Türkiye TEL +90 2164229010. Ürünün hangi yaş grubuna ait olduğu kutunun ön yüzünde belirtilmiştir. 'M' harfi ile belirtilen sayılar 'ay' anlamına gelmektedir.