

取扱説明書
対象年齢
15才以上

トランスフォーマー マーレカシー ユナイテッド
**TRANSFORMERS LEGACY
UNITED**

※本書をご確認後は、必ず保管しておいてください。



TRANSFORMERS

CYBERTRON UNIVERSE
HOT SHOT

Manufactured under license from TOMY Company, Ltd. TAKARATOMY logo is property of Tomy Company, Ltd. TRANSFORMERS and HASBRO and all related trademarks and logos are trademarks of Hasbro, Inc. © 2024 Hasbro.

Hasbro, Pawtucket, RI 02861-1059 USA. HASBRO CANADA, LONGUEUIL, QC, CANADA J4G 1G2. US/CANADA TEL. 1-800-255-5516. Importado por: HASBRO DE MEXICO, S. DE R.L. DE C.V. Boulevard Manuel Avila Camacho #32, piso 3, Colonia Lomas de Chapultepec I Sección, Alcaldía Miguel Hidalgo, C.P. 11000, Ciudad de México, México. Centro de Servicio para México: TEL. 5876-2998 y para el Interior de la República TEL. 01-800-7-12-62-25. Manufactured by/Produced by: Hasbro SA, Rue Emile-Boechat 31, 2800 Delémont, CH. Represented by/Representat de: Hasbro, De Entree 240, 1101 EE Amsterdam, NL. © Hasbro UK Ltd., P.O. Box 43, Newport, NP19 4YH, UK. Üretici Firma Bilgileri: Hasbro SA, Rue Emile-Boechat 31, 2800 Delémont İsviçre TEL. +41 324210800. Hasbro Oyuncak San. ve Tic. A.Ş. tarafından ithal edilmiştir. Tüketici Hizmetleri: Burhaniye Mah. Abdullahağa Cad. No: 51/2 34676 Beylerbeyi İstanbul Türkiye TEL. +90 2164229010.



TAKARA TOMY



FBS35/F2990 Asst. PH00087788



180°

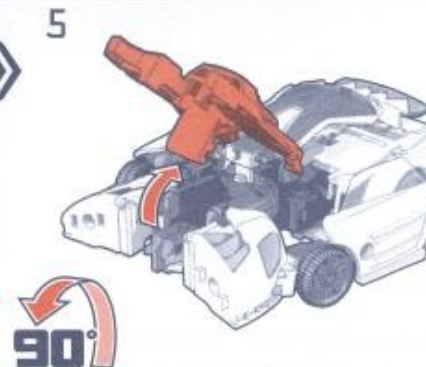
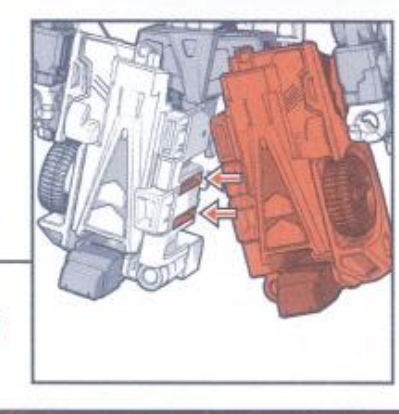
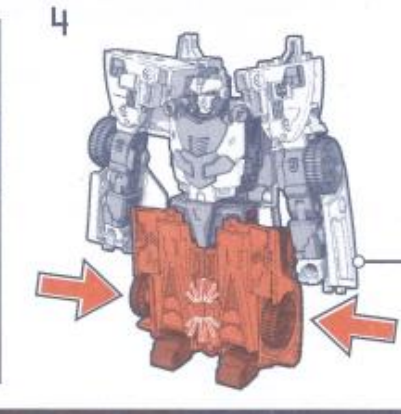
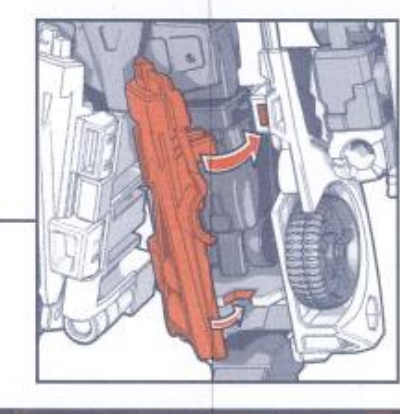
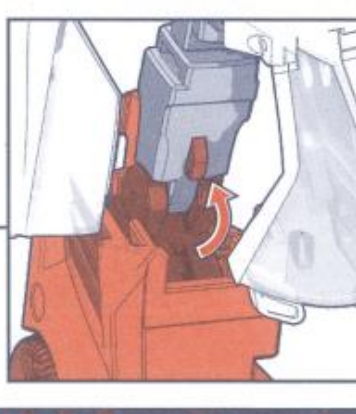
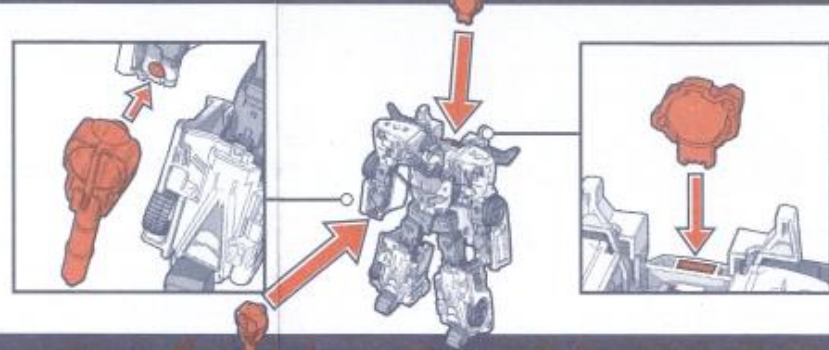
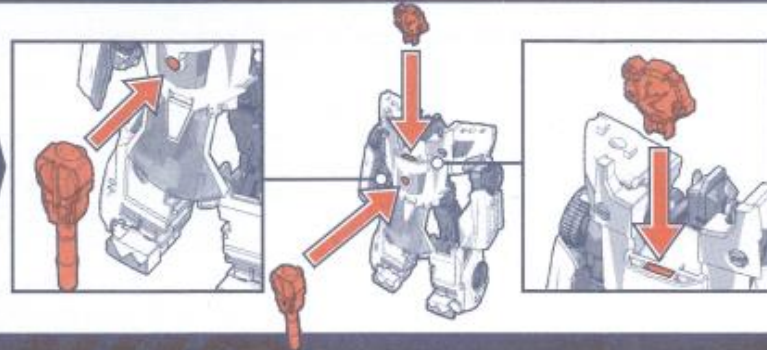

90°

